

MI3

Noncontact Temperature Measurement for Industrial Applications and OEMs

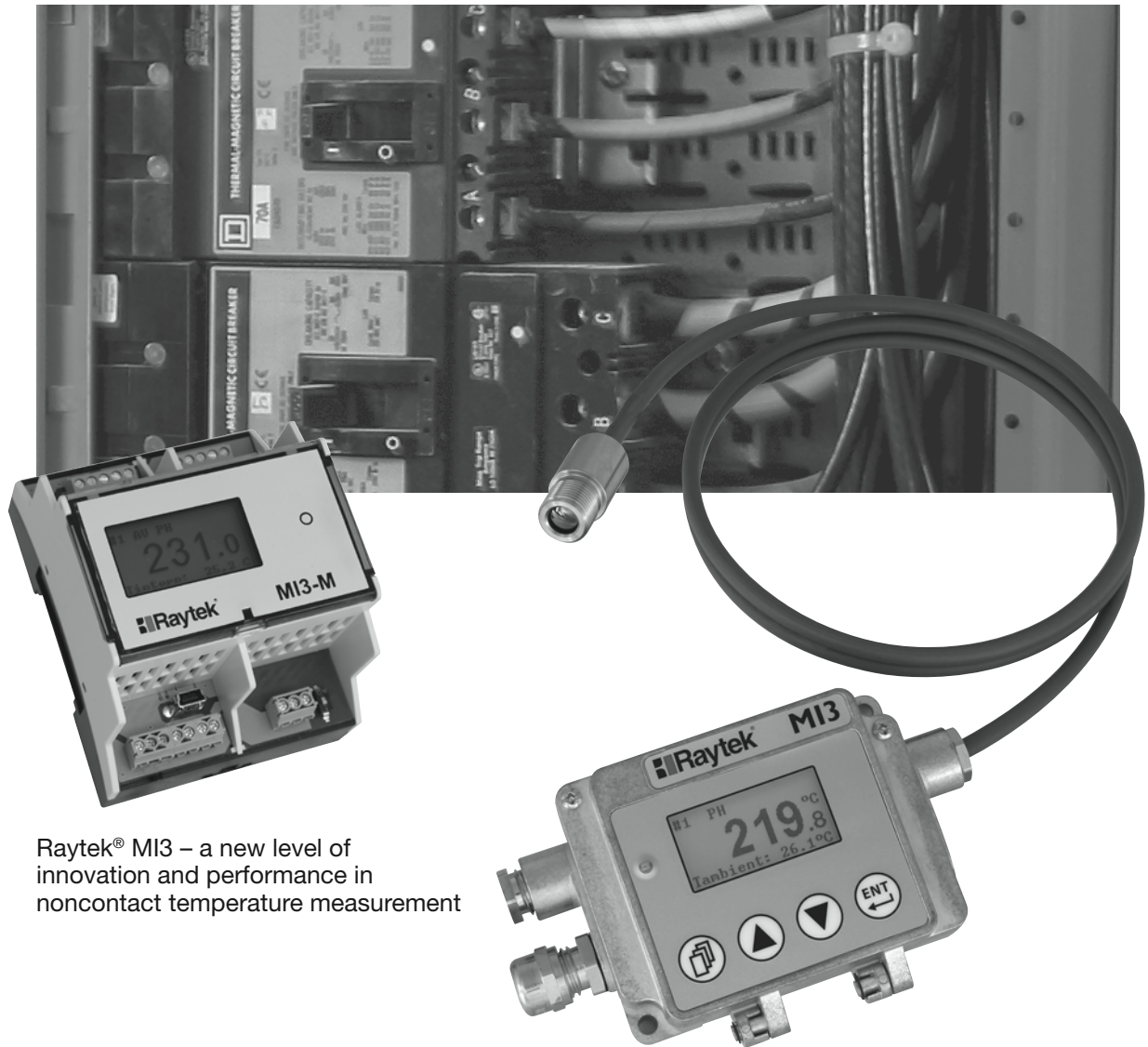

Raytek® MI3 – a new level of innovation and performance in noncontact temperature measurement

MI3 Highlights

- Innovative multi-sensor design—up to 8 sensing heads/ system, each individually addressable
- Fast response times of < 20 mSec
- Rugged IP65 rated sensing heads survive ambient temperatures to 120°C (248°F) without cooling
- Intuitive user interface with high resolution LCD display for easy set-up
- Precision high resolution optics, up to 22:1
- User configurable analog outputs (0/4-20mA, 0-5/10V, type J, K, R or S t/c)
- Standard USB 2.0 digital interface for remote set-up
- Optional network communications module (RS485)
- Miniature sensing head fits where other sensors can't
- Isolated alarm relay outputs
- Adjustable Emissivity, Peak Hold, Valley Hold and Averaging functions
- Datatemp® Multi-drop and field calibration software included
- Full range of accessories
- Automatic sensing head detection

The Raytek® MI3 is a powerful two-piece infrared temperature measurement system with miniature sensing head and separate communications electronics. The sensor is small enough to be installed just about anywhere, yet it outperforms much larger systems. Available in either a rugged cast metal electronics enclosure, an innovative multi-channel DIN mountable enclosure, or low cost OEM configurations, the MI3 offers a host of advanced signal processing features you won't normally find in sensors costing much more.

Designed for an endless range of applications, the MI3 features a variety of sensing head options. Low temperature sensors with a measurement range of -40°C to 1000°C (-40°F to 1832°F), fast response (<20 mSec) sensors, and 5 μm spectral response sensors, provide an impressive array of solutions for your process needs. The rugged stainless steel sensing head ensures reliable long term performance in the harshest industrial environments. Although the MI3 sensor is small in size, it has all the performance you need—with 1% accuracy, a choice of high resolution optics up to 22:1 and user configurable I/O.

Standard features include adjustable Emissivity, Peak Hold, Valley Hold, and Averaging functions. All sensor parameters are easily adjustable on the built-in user interface keypad, or remotely with the DataTemp software via the built-in USB interface. Advanced features further extend the power of the MI3 and include user configurable alarm output, digital "recipe" table inputs that can be easily interfaced to an external control system, an external reset input for signal processing, and external inputs for analog emissivity adjustment or reflected energy compensation.

The MI3's miniature size and low cost per measurement point make it ideal for installation at multiple points in your process. The MI3 is accurate, rugged, affordable, easy-to-install and operate. With the MI3, precision infrared temperature measurement is now an economical alternative.

Raytek MI3 – a new level of innovation and performance in noncontact temperature measurement!

Specifications

Spectral Response:	
LT (Low Temp.)	8 to 14 microns
G5	5 microns
Optical Resolution:	
LTS	2:1, 10:1, 22:1
LTF	10:1
G5	22:1
Temperature Range:	
LTS (2:1, 10:1)	-40°C to 600°C (-40°F to 1112°F)
LTF (LTS 22:1)	0°C to 1000°C (32°F to 1832°F)
G5	250°C to 1650°C (482°F to 3002°F)
System Accuracy:	
	±1% of reading or ±1°C, whichever is greater
	Thermocouple output accuracy
	±1% of reading or ±2.5°C, whichever is greater
System Repeatability:	
	±0.5% of reading or ±0.5°C (1°F), whichever is greater
Temperature Coefficient: 0.05°K per °K	
Temperature Resolution:	
LT	0.1°C or 0.2°F *
System Response Time:	
LTS	130ms (90%)
LTF	20ms (90%)
G5	55ms (90%)
Emissivity: 0.100 to 1.100 digitally adjustable Increments of .001	
Transmission: 0.100 to 1.000 digitally adjustable Increments of .001	
Signal Processing: Peak hold, valley hold, variable averaging filter, adjustable up to 998 seconds	

*Scaled temperature dynamic range < 500°C (< 932°F)

Nominal Optical Specifications

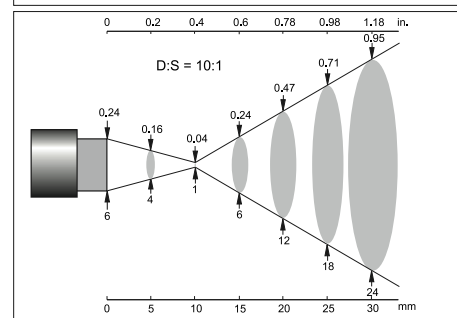
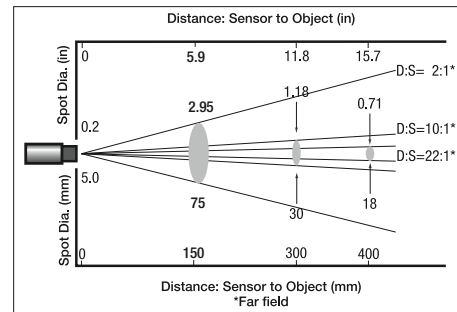

10:1 with Close Focus Accessory

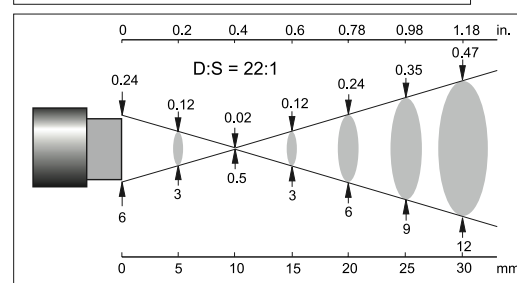

22:1 with Close Focus Accessory

D:S is the optical resolution expressed as a ratio of the distance to the measurement spot divided by the diameter of the spot.

Optical resolution for the MI3 is 2:1, 10:1, 22:1.

Nominal spot size based on 90% energy.

Electrical Specifications MI3COMM

Digital Interface	USB 2.0
Outputs:	Scale able 4-20mA, 0-20mA, 0-10V, 0-5V, J, K, R or S thermocouple, 0-5V head ambient output
Inputs:	Digital inputs for emissivity control, ambient background temperature compensation, trigger/hold input
Alarm Relay:	48 VAC, 300 mA, optically isolated
Cable Length:	1m (3.3ft) standard, 3m (10ft), 8m (26ft), 15m (50ft) and 30m (100ft) lengths available
Output Impedance (T/C output):	20 ohms
Minimum Load Impedance (mV output):	10K ohms
Maximum Loop Impedance (mV output):	500 ohms
Power Draw:	4W max
Power Supply:	8-32VDC
Environmental Rating:	IP 65 (NEMA-4)
Electronics Housing:	-10°C to 65°C (14°F to 150°F)
Storage Temperature:	-20°C to 85°C (-4°F to 185°F)
Relative Humidity:	10 to 95%, non-condensing
Electronics Weight:	270g (9.5oz)
EMI/EMC/ESD	IEC EN61326-1 1:2006

Electrical Specifications MI3MCOMM

Digital Interface	USB 2.0 and RS485
Inputs:	Trigger input
Alarm Relay:	48 VAC, 300 mA, optically isolated
Cable Length*:	1m (3.3ft) standard, 3m (10ft), 8m (26ft), 15m (50ft) and 30m (100ft) lengths available
Power Draw:	4W max
Power Supply:	8-32VDC
Electronics Housing:	-10°C to 65°C (14°F to 150°F)
Storage Temperature:	-20°C to 85°C (-4°F to 185°F)
Relative Humidity:	10 to 95%, non-condensing

*Maximum total cable length of 60m (197ft)

Sensing Head Specifications

Environmental Rating:	IP 65 (NEMA-4)
Head Ambient Temperature Range:	-10°C to 120°C (14°F to 248°F)
S and F models:	-10°C to 120°C (14°F to 248°F)
Storage Temperature:	-20°C to 85°C (-4°F to 185°F)
Relative Humidity:	10 to 95%, non-condensing
Construction:	
Sensing head	Stainless steel
Comm box (MI3)	Zinc, die-cast
DIN Comm box (MI3M)	Molded plastic
Sensing head cable	PUR halogen free, flame retardant insulation, 125°C (257°F) max. temp
Weight:	
Sensing head (w/1 m cable)	50g (1.75oz)
Shock (sensing head)	IEC 68-2-27 50g's, 11ms, 3 axis
Vibration (sensing head)	68-2-6 3g's, 10-150Hz, 3 axis
EMI/EMC/ESD	IEC EN61326-1 1:2006

Accessories

A full range of accessories for various applications and industrial environments are available. Accessories include items that may be ordered at any time and added on-site:

- (XXXSYSPS) 24 VDC, 1.2A Power supply
- (XXXMIACAB) Adjustable mounting bracket
- (XXXMIACFB) Fixed mounting bracket
- (XXXMIACMN) Sensor head mounting nut
- (XXXMIACAJ) Air purge jacket
- Air cooling system with .8 m (2.6 ft) air hose (XXXMIACCJ) or with 2.8 m (9.2 ft) air hose (XXXMIACCJ1)
- (XXXMIACRAJ, XXXMIACRAJ1) Right angle mirror
- (XXXMIACPW, XXXMI3ACPWP) Protective windows
- (XXXMI3ACCFL) Close focus lens
- (XXXMICONNBOX) Multi-channel sensor interface box
- (XXXUSB485) USB/RS485 Adapter for boxes with RS485 interface

Sensor Dimensions

Sensing Head

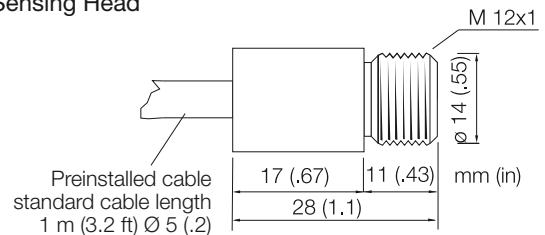

MI3 Electronics Housing

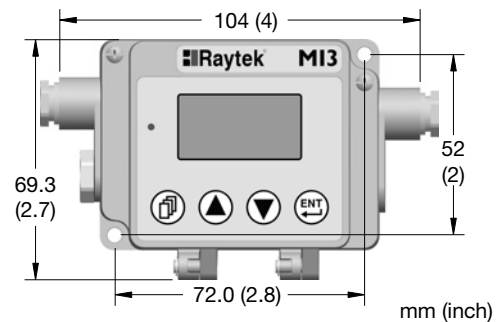

MI3M Multi-channel Electronics Housing

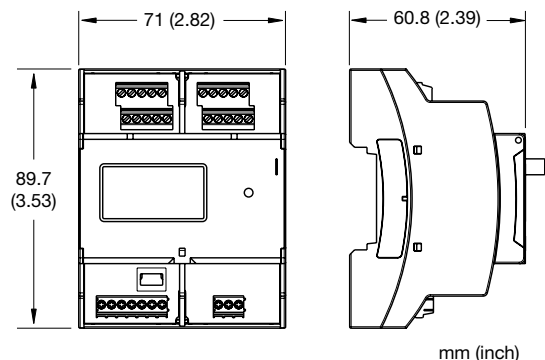

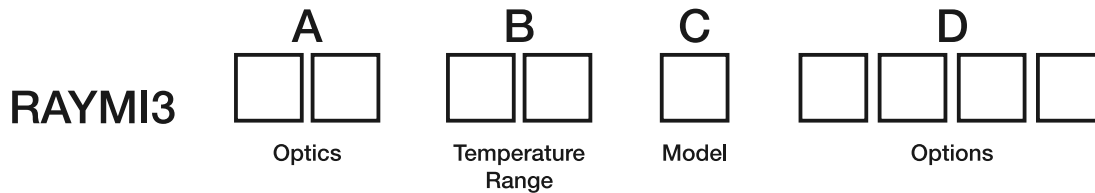

Each MI3 sensor is comprised of (1) MI3 sensing head and (1) MI3COMM or MI3MCOMM communication module. The sensing head includes one mounting nut and 1m (3.3ft) cable. Longer cables up to 30 m (100ft) maximum are available and must be specified at time of order.

Model	Description
RAYMI3	Miniature infrared sensing head with 1 meter (3.3ft) cable
Code A	Optical Resolution
02	2:1
10	10:1
20	22:1
Code B	Temperature Range
LT	-40°C to 600°C (-40°F to 1112°F) Note: 0°C to 1000°C (32°F to 1832°F) for LTF and LTS 22:1 models
G5	250°C to 1650°C (482°F to 3002°F)
Code C	Model
S	Standard sensing head, 120°C (248°F) maximum ambient
F	Fast response sensing head, 20 mSec response time, 120°C (248°F) maximum ambient
Code D	Options
CB3	3m (10ft) cable
CB8	8m (26ft) cable
CB15	15m (49ft) cable
CB30	30m (98ft) cable



Model	Description
RAYMI3COMM	MI3 IR thermometer communication box with USB 2.0 communications, cast zinc housing and user-interface
Code A	MI3 Options
4	RS-485 communication option
RAYMI3MCOMM	Modular DIN mountable 4-channel IR communication box with user interface, USB 2.0 and RS485 communications

The Worldwide Leader in Noncontact Temperature Measurement

Raytek Corporation
Worldwide Headquarters
 Santa Cruz, CA USA
 Tel: 1 800 227 8074 (USA and Canada, only)
 1 831 458 3900
solutions@raytek.com

European Headquarters
 Berlin, Germany United Kingdom
 Tel: 49 30 4 78 00 80 Tel: 44 1908 630 800
raytek@raytek.de ukinfo@raytek.com

China Headquarters
 Beijing, China
 Tel: 8610 6438 4691
info@raytek.com.cn

To find a Raytek office near you, please visit www.raytek.com

Worldwide Service

Raytek offers services, including repair and calibration.
 For more information, contact your local office or e-mail support@raytek.com

www.raytek.com



© 2010 Raytek Corporation (3783599 Rev A) 4/2010
 Raytek, the Raytek logo and DataTemp are registered trademarks of Raytek Corporation.
 Specifications subject to change without notice.